

Ultrasonic sensors

Osisonic

Catalogue
October

04

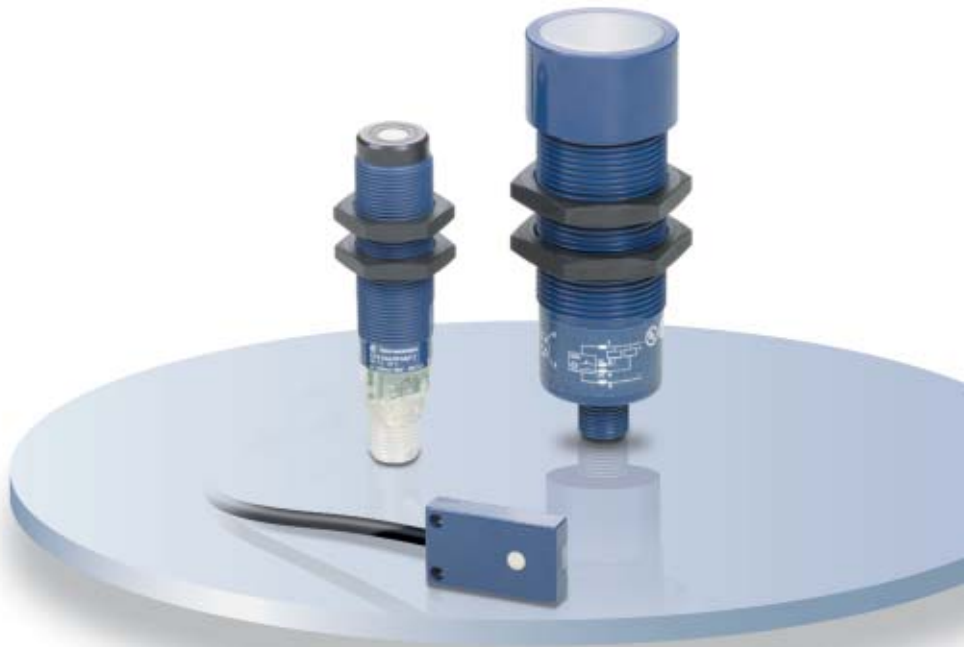

Osisonic[®], Optimum and Universal

Selection guide *pages 2 and 3*

■ General *pages 4 to 9*

**Cylindrical plastic case,
M12 x 1, M18 x 1, M30 x 1,5
d.c supply, solid-state output**

■ References *page 10*

■ Characteristics, setting-up *page 11*

■ Dimensions *page 12*

■ Curves, schemes *page 13*

**Cylindrical plastic case,
M30 x 1,5
Sensors with analogue output signal
0...10V or 4-20 mA**

■ References *page 14*

■ Characteristics, setting-up *page 15*

■ Dimensions *page 16*

■ Curves, schemes *page 17*

**Plastic case, flat form
d.c. supply, solid-state output**

■ References *page 18*

■ Characteristics, setting-up *page 19*

■ Dimensions *page 20*

■ Curves, schemes *page 21*

Ultrasonic sensors

Osisonic[®], Optimum and Universal

Applications
 Detection of any object without physical contact, irrespective of:
 - material (metal, plastic, wood, cardboard, etc.),
 - nature (solid, liquid, powder, etc.),
 - colour,
 - degree of transparency.

Dimensions (mm)

Cylindrical sensors - Solid-state digital output

Ø 12 Ø 18 Ø 30



Sensing distance Sn	5 cm	10 cm	15 cm	50 cm (adjustable)	1 m (adjustable)	8 m (adjustable)
Assured sensing distance (mm)	6.4...51, fixed	6.4...102, fixed	25...152, fixed	Adjustable using teach mode		
Type of output	PNP/NPN	NPN or PNP	PNP/NPN	NPN or PNP	PNP/NPN or NPN or PNP	NPN or PNP
Degree of protection	IP 67	IP 67	IP 67	IP 67	IP 65	IP 65
Function	NO	NO	NO	NO	NO or NO + NC	NO + NC
Connector	●	●	●	●	●	●
Power supply	⎓ 12...24 V with protection against reverse polarity					
Sensor type	XX5 12A●		XX5 18A●		XX6 30A●	
Pages	10 to 13					

Cylindrical sensors - Analogue output

Ø 30



Flat form sensors - Solid-state digital output

7.6 x 19 x 33

16 x 30 x 74

18 x 33 x 60 + Ø 18



1 m (adjustable)	8 m (adjustable)	1 m (adjustable)	8 m (adjustable)
Adjustable using teach mode			
4-20 mA		0-10 V	
IP 65			
-			
●		●	
⎓ 15...24 V with protection against reverse polarity			
XX9 30A●			
14 to 17			

10 cm	25 cm	50 cm (adjustable)
6.4...102, fixed	51...254, fixed	Adjustable using teach mode
NPN or PNP	NPN or PNP	NPN or PNP
IP 67		
NO		
Connector on flying lead	●	●
⎓ 12...24 V with protection against reverse polarity		
XX7 F1A2	XX7 K1A2	XX7 V1A1
18 to 21		

Quality, standards and certifications

Quality control

The Osisonic ultrasonic sensors are subjected to special precautions in order to guarantee their reliability in the most arduous industrial environments.

■ Qualification

A qualification procedure on the characteristics of Osisonic ultrasonic sensors is carried out in our laboratories.

■ Production

- The electrical characteristics, sensing distances at the ambient temperature and operating temperatures are 100% verified.
- Sensors are randomly selected during the course of production and subjected to **monitoring tests** on all qualified characteristics.

■ Customer returns

Defective ultrasonic sensors are subjected to systematic analysis and corrective actions are implemented to eliminate recurrence of the fault.

Conformity to standards

The Osisonic ultrasonic sensors conform to the standards IEC 60947-5-2.
Standards and characteristics: refer to page 11.

Resistance to chemicals in the environment

To ensure lasting efficient operation, it is essential that any chemicals coming into contact with the ultrasonic sensors will not affect their casing and, in doing so, prevent their reliable operation.

Due to the materials used, Osisonic ultrasonic sensors are very resistant to:

■ chemical agents:

- salts, aliphatic and aromatic oils,
- petroleum, diluted bases and acids.

Depending on their nature and concentration, tests should be carried out beforehand for the following chemical agents:

- alcohols, ketones and phenols.

■ food and beverage industry products:

- vegetable oils, animal fats,
- fruit juices,
- milk proteins, etc.

Resistance to the environment

■ IP 65: protection against water jets.

Test according to IEC 60529: the device is subjected to water sprayed from a Ø 6,3 mm nozzle, at a flow rate of 12,5 litres/min for 3 min at a distance of 3 m.
No deterioration in either operating or insulation characteristics is permitted.

■ IP 67: protection against the effects of immersion.

Tested in accordance with IEC 60529: sensor immersed for 30 minutes in 1 m of water.
No deterioration in either operating or insulation characteristics is permitted.

Recommendations

The ultrasonic sensors are designed for use in standard industrial applications involving presence detection.
 Since these sensors do not incorporate a redundant electrical circuit, they are not suitable for use in safety applications.
 For safety applications, please refer to our "Safety solutions using Preventa" catalogue.

Principle of ultrasonic detection



Presentation

Ultrasonic sensors enable detection, without contact, of any object irrespective of its:

- material (metal, plastic, wood, cardboard, etc.),
- nature (solid, liquid, powder, etc.),
- colour,
- degree of transparency.

They are used in industrial applications for detecting, for example:

- the position of machine parts,
- the presence of the windscreen during automobile assembly,
- the flow of objects on a conveyor system: glass bottles, cardboard packages, cakes, etc.,
- the level
- of different colour paints in pots,
- of plastic pellets in injection moulding machine feeders.

The ultrasonic sensors are simple to install due to their integral connector and availability of cabling and fixing accessories.

Operating principle

The principle of ultrasonic detection is based on measuring the time taken between transmission of an ultrasonic wave (pressure wave) and reception of its echo (return of transmitted wave).

Osisonic ultrasonic sensors are of the cylindrical type. They comprise:

- 1 high voltage generator
- 2 piezoelectric transducer (transmitter and receiver)
- 3 signal processing stage
- 4 output stage

Excited by the high voltage generator **1**, the transducer (transmitter-receiver) **2** generates a pulsed ultrasonic wave (200 to 500 kHz depending on the product) which travels through the ambient air at the speed of sound. When the wave strikes an object, it reflects (echo) and travels back towards the transducer. A micro controller **3** analyses the signal received and measures the time interval between the transmitted signal and the echo. By comparison with the preset or learnt times, it determines and controls the output states **4**.

The output stage **4** controls a solid-state switch (PNP or NPN transistor) corresponding to a NO or NC contact (detection of object).

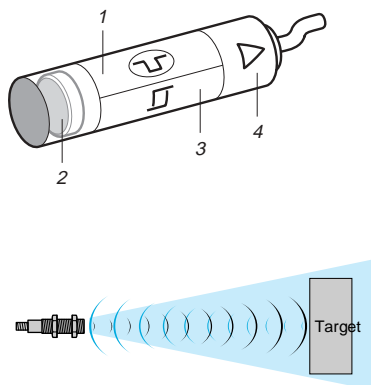

Advantages of ultrasonic detection

- No physical contact with the object to be detected, therefore, no wear and detection possible of fragile or freshly painted objects, etc.
- Detection of any material, irrespective of colour, at the same distance, without adjustment or correction factor.
- Teach mode function, by simply pressing a button, for defining the effective sensing range. Teach of the minimum and maximum sensing distances (very precise foreground and background suppression, ± 6 mm).
- Very good resistance to industrial environments (robust products entirely encapsulated in resin).
- Solid-state units: no moving parts in the sensor, therefore, service life independent of the number of operating cycles.

Terminology

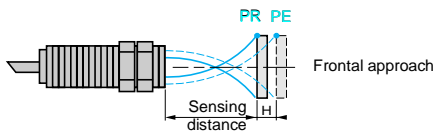
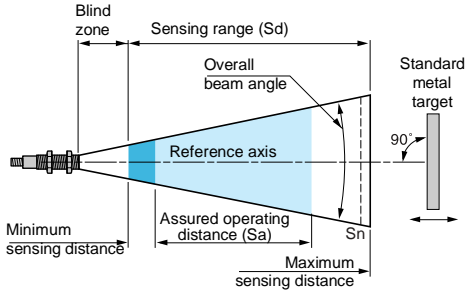

PR = drop-out point
PE = pick-up point

Definitions

The terms listed below are defined by the standard IEC 60947-5-2:

- **Nominal sensing distance (Sn)**
Conventional value for indicating the sensing distance. It does not take into account manufacturing tolerances nor variations caused by external conditions such as voltage and temperature.
- **Sensing range (Sd)**
Zone in which the sensor is sensitive to objects.
- **Minimum sensing distance**
Lower limit of the specified sensing range.
- **Maximum sensing distance**
Upper limit of the specified sensing range.
- **Assured operating distance (Sa)**
This corresponds to the operating zone of the sensor (activation of outputs), and is included in the sensing range.
Its limits are fixed:

 - at the factory for fixed sensing distance sensors,
 - when setting-up within the application for sensors with teach mode.
- **Blind zone**
Zone between the sensing face of the sensor and the minimum sensing distance in which no object can be reliably detected.
Avoid any passing of objects in this blind zone during operation of the sensor. This could lead to instability of the output states.
- **Differential travel**
The differential travel (H) or hysteresis is the distance between the pick-up point as the standard metal target moves towards the sensor and the drop-out point as it moves away from the sensor.
- **Repeat accuracy**
The repeat accuracy (R) is the precision of reproduction between two successive measurements of the sensing distance, made in identical conditions.
- **Overall beam angle**
Solid angle around the reference axis of an ultrasonic proximity sensor.
- **Standard target**
The standard IEC 60947-5-2 defines the standard target as a square metal plate, 1 mm thick with rolled finish, placed perpendicularly to the reference axis.
Its side dimension depends on the sensing range:

Sensing range (mm)	Size of target (mm)
< 300	10 x 10
300 < d < 800	20 x 20
> 800	100 x 100

- **Voltage drop (Ud)**
The voltage drop (Ud) corresponds to the voltage at the terminals of the sensor when in the closed state (value measured at the nominal current of the sensor).

- **First-up delay**
Time required to ensure operation of the sensor's output signal following power-up.
1 Power-up
2 Output signal state (0 or 1)

- **Response time**

 - Response time (Ra): time taken between the instant the object to be detected enters the active zone and the changing of the output signal state. This time limits the passing speed of the target in relation to its dimensions.
 - Recovery time (Rr): time taken between the object being detected leaving the active zone and the changing of the output signal state. This time limits the interval between 2 objects.

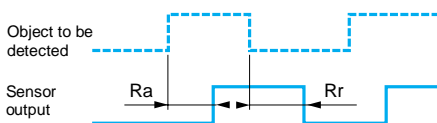
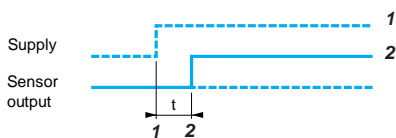
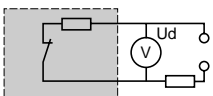

Digital outputs

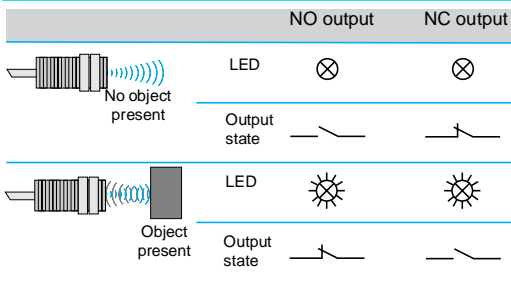

LED indicators

The majority of Osisonic ultrasonic sensors incorporate light-emitting diode output state indicators.

- Ø 12 sensor, sensitivity 50 mm
 - Green LED (power on)
 - Yellow LED (object present).
- Ø 12 sensor, sensitivity 100 mm
 - Green LED (power on)
 - Yellow LED (object present).
- Ø 18 sensor, sensitivity 500 mm
 - Yellow LED (object present) and green (power on) LED + user assistance when adjusting the detection zone.
- Ø 30 sensor, sensitivity 1 to 8 m
 - Multicolour LED for assisting the user when adjusting the detection zone
 - Yellow LED (object present).
- Ø 30 sensor, sensitivity 1 to 8 m with analogue output
 - Multicolour LED for assisting the user when adjusting the detection distance
 - Yellow LED (object present, with luminosity increasing as output signal increases).
- Parallelepiped format sensor
 - XX7 F: Dual colour yellow (object present) and green (power on) LED
 - XX7 V: Dual colour yellow (object present) and green (power on) LED + user assistance when adjusting the detection zone
 - XX7 K: Yellow LED (object present) and green (power on) LED.

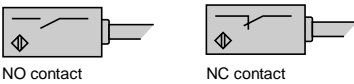

Sensors with digital switching

Contact logic output

- Normally open (NO)

Corresponds to a sensor whose output changes to the closed state when an object is present in the operating zone.
- Normally closed (NC)

Corresponds to a sensor whose output changes to the closed state when an object is present in the operating zone.

4-wire technique

NO output/ PNP and NPN

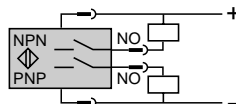

NO + NC output/ NPN

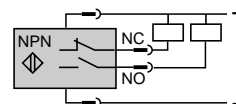

NO + NC output/ PNP

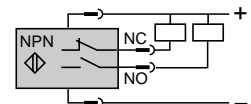

These sensors comprise 2 wires for the supply and 1 wire for each output signal.

3-wire technique

NO output / NPN

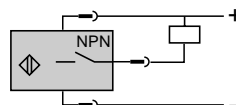

NO output / PNP

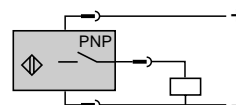

These sensors comprise 2 wires for the supply and 1 wire for the output signal.

PNP type: switching the positive side to the load

NPN type: switching the negative side to the load

Sensors with analogue output

Operation

The characteristic feature of these sensors is the output which delivers a signal (either current or voltage) that is proportional to the distance of the object being detected. Within the detection limits, which are adjustable using teach mode, the value of the output signal increases as the object moves away.

When an object is detected, an LED indicator (D) illuminates and its luminosity increases in relation to the value of the output signal.

Advantages

- Visual information available relating to the sensor / object distance.
- Protection against reverse polarity.
- Protection against overloads and short-circuits.
- No residual current, low voltage drop.

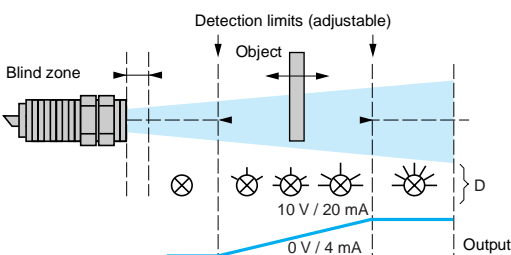

Power supply

d.c. source

Check that the voltage limits of the sensor and the acceptable level of ripple, are compatible with the supply used.

a.c. source (comprising transformer, rectifier, smoothing capacitor)

The supply voltage must be within the operating limits specified for the sensor.

Where the voltage is derived from a single phase a.c. supply, the voltage must be rectified and smoothed to ensure that:

- the peak voltage of the d.c. supply is lower than the maximum voltage rating of the sensor.

Peak voltage = nominal voltage $\times \sqrt{2}$

- the minimum voltage of the d.c. supply is greater than the minimum voltage rating of the sensor, given that:

$$\Delta V = (I \times t) / C$$

ΔV = maximum ripple: 10 % (V),

I = anticipated load current (mA),

t = period of 1 cycle (10 ms full-wave rectified for a 50 Hz supply frequency),

C = capacitance (μF).

As a general rule, use a transformer with a lower secondary voltage (U_e) than the required d.c. voltage (U).

Example:

$\sim 18 \text{ V}$ to obtain $\approx 24 \text{ V}$.

Setting-up precautions

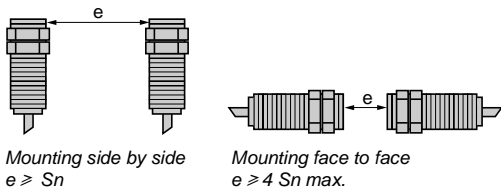

Mounting side by side
 $e \geq S_n$

Mounting face to face
 $e \geq 4 S_n \text{ max.}$

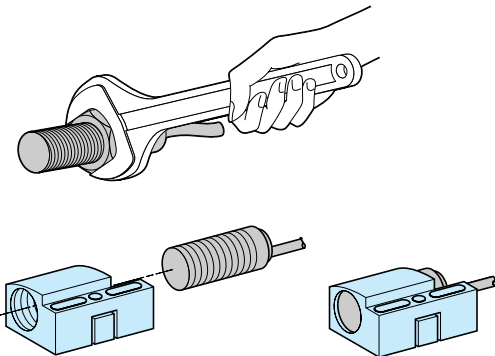

Mounting

Mounting distance between ultrasonic sensors

If 2 standard sensors are mounted too close to each other, the wave transmitted by one sensor is likely to interfere with the other and result in erratic operation.

In order to avoid this, it is necessary to adhere to the minimum distances between sensors.

Maximum tightening torque

Cylindrical sensor	Diameter mm	Tightening torque	Flat form sensors	Screw	Tightening torque
XX5 12●	∅ 12	0,7 N.m	XX7 F●	M3	0,7 N.m
XX5 18●	∅ 18	1 N.m	XX7 K●	M4	1 N.m
XX6 30●	∅ 30	1,35 N.m	XX7 V●	M3	0,7 N.m
				∅ 18	1 N.m

Interchangeability

Using the indexed **fixing clamp**, the assembly is similar to a block type sensor.

Cabling

Electrical connection

- Connect the sensor before switching on the supply

Length of cable

- No limitation up to 200 m or up to a line capacitance of $< 0.1 \mu\text{F}$ (characteristics of sensor remain unaffected).
- It is, however, advisable to take into account the voltage drop on the line.

Separation of control and power cables

- The sensors are immune to electrical interference encountered in normal industrial conditions.
- Where extreme conditions of electrical "noise" could occur (large motors, spot welders, etc.), it is advisable to protect against transients in the normal way:
 - suppress interference at source,
 - separate power and control wiring from each other,
 - smooth the supply,
 - limit the length of cable.

Setting-up precautions (continued)

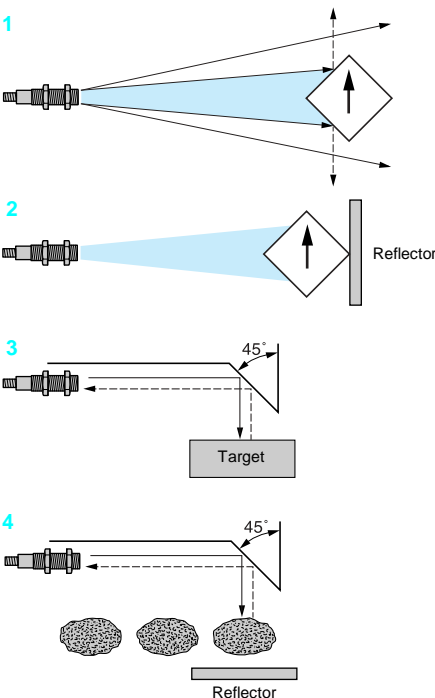
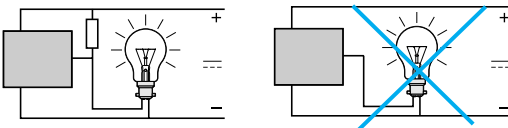
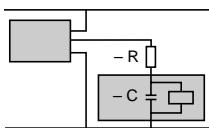
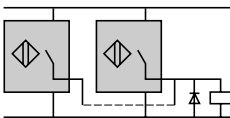
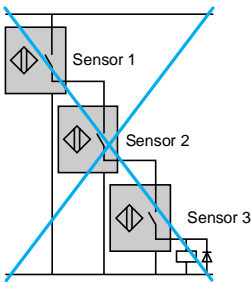

Connection in series

This connection method is not recommended.

Correct operation of the sensors cannot be assured and, if this method is used, tests must be made before installation. The following points should be taken into account:

- Sensor 1 carries the load current in addition to the no-load current consumption values of the other sensors connected in series. For certain models, this connection method is not possible unless a current limiting resistor is used.
- When in the closed state, each sensor will produce a voltage drop and, therefore, the load voltage should be selected accordingly.
- As sensor 1 closes, sensor 2 will not operate until a certain time "T" has elapsed (corresponding to the first-up delay) and likewise for the following sensors in the sequence.
- "Flywheel" diodes should be used when the load being switched is inductive.

Sensors and units in series with an external mechanical contact

The following points should be taken into account:

- When the mechanical contact is open, the sensor is not supplied.
- When the contact closes, the sensor will not operate until a certain time "T" has elapsed (corresponding to the first-up delay).

Connection in parallel

No specific restrictions. The use of "flywheel" diodes is recommended when an inductive load (relay) is being switched.

Capacitive load (C > 0.1 µF)

At switch-on, it is necessary to limit (by resistor) the charging current of the capacitive load C. The voltage drop in the sensor can also be taken into account by subtracting it from the supply voltage for the calculation of R.

$$R = \frac{U \text{ (supply)}}{I \text{ max. (sensor)}}$$

Load comprising an incandescent lamp

If the load comprises an incandescent lamp, the cold state resistance can be 10 times lower than the hot state resistance. This can cause very high current levels on switching. Fit a pre-heat resistance in parallel with the sensor.

$$R = \frac{U^2}{P} \times 10, U = \text{supply voltage and } P = \text{lamp power}$$

Detection

Influencing factors

The ultrasonic sensors are particularly suited to the detection of a hard object with a flat surface perpendicular to the detection axis.

However, the correct operation of the ultrasonic sensor can be disrupted by:

- air currents, which can accelerate or divert the acoustic wave transmitted by the sensor (ejection of part by air jet),
- high temperature gradients within the sensing range: an object emitting considerable heat can create zones of varying temperature that will modify the propagation time of the wave and thus prevent reliable operation,
- sound insulators: sound absorbing materials (cotton, fabrics, rubber, etc.),
- the angle between the face of the object to be detected and the reference axis of the sensor: when the angle is offset from 90°, the wave is no longer reflected back along the sensor axis and the operating distance is reduced. The greater the distance between the sensor and the target, the greater the effect. Detection is not possible when the angle exceeds ± 10°.
- the shape of the object to be detected: similar to the example above, an excessively angular object can be difficult to detect 1.

Detection by beam break (reflex system)

In cases requiring detection of sound insulating materials, angular objects, or an angle exists between the face of the object to be detected and the reference axis of the sensor, it is recommended that a sensor with the teach mode feature be selected, which enables beam break detection using a reflector. This reflector can be any flat, hard and fixed part of the machine 2. The sensor with the teach mode feature can also be used in confined spaces by using a 90° reflector. In the same manner as for the return reflector, the 90° reflector can be a flat part of the machine 3.

It is also possible to use beam break detection (reflex system) with the 90° reflector 4.

Caution: in reflex mode, the NO function opens when an object is present and the NC function closes when an object is present.

Ultrasonic sensors

Osisonic[®], Optimum and Universal

Cylindrical plastic case, M12 x 1, M18 x 1, M30 x 1.5 d.c. supply, solid-state output



XX5 12A1KAM8

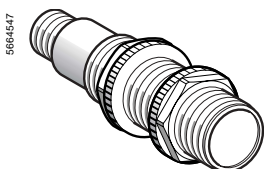

XX5 18A1KAM12

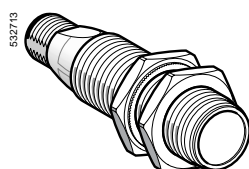

XX5 18A3AM12

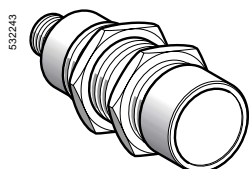

XX6 30A1KAM12

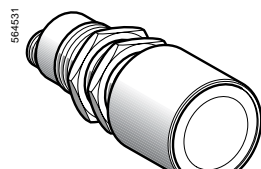

XX6 30A3CM12

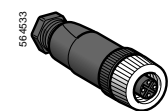

XZ CC12FD40B



XXZ PB100

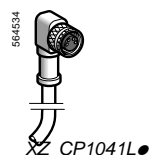

XZ CP1041L

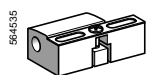

XSZ B11



XUZ A118

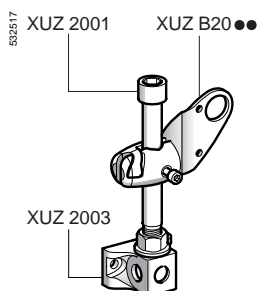

3D fixing kit example

Optimum sensors

Sensors	Sensing distance (Sn) m	Function	Output	Reference	Weight kg
Ø 12	0.05	NO	PNP/NPN	XX5 12A1KAM8	0.011
	0.10	NO	NPN	XX5 12A2NAM8	0.011
			PNP	XX5 12A2PAM8	0.011
Ø 18	0.15	NO	PNP/NPN	XX5 18A1KAM12	0.033

Universal sensors

Ø 18	0.50 (adjustable)	NO	NPN	XX5 18A3NAM12	0.033
			PNP	XX5 18A3PAM12	0.033
Ø 30	1 (adjustable)	NO	PNP/NPN	XX6 30A1KAM12	0.091
		NO + NC	NPN	XX6 30A1NCM12 (1)	0.091
		PNP	XX6 30A1PCM12 (1)	0.091	
	8 (adjustable)	NO + NC	NPN	XX6 30A3NCM12	0.110
			PNP	XX6 30A3PCM12	0.110

Accessories

Teach mode pushbutton

Teach mode pushbutton	For use with sensors	Reference	Weight kg
Selection of detection window Input: M12 female connector Output: M12 male connector	XX5 18A3AM12 and XX7 V1A1AM12	XXZ PB100	0.035

Cabling accessories (4-wire output) (3)

Connectors	For use with sensor	Type	Reference	Weight kg				
M8	Ø 12	Connection by in-line IDC	Straight	XZ CC8FDM40V	0.010			
			Elbowed	XZ CC8FCM40V	0.010			
		Connection to solder terminals	Straight	XZ CC8FDM40S	0.010			
			Elbowed	XZ CC8FCM40S	0.010			
M12	Ø 18, Ø 30	Metal clamping ring	Straight	XZ CC12FDM40B	0.020			
			Elbowed	XZ CC12FCM40B	0.020			
		Plastic clamping ring	Straight	XZ CC12FDP40B	0.020			
			Elbowed	XZ CC12FCP40B	0.020			
		Pre-wired connectors	For use with sensor	Type	Length m	Reference		Weight kg
						Reference		
M8	Ø 12			Straight	2	XZ CP0166L2	0.080	
					5	XZ CP0166L5	0.180	
					10	XZ CP0166L10	0.360	
				Elbowed	2	XZ CP0266L2	0.080	
					5	XZ CP0266L5	0.180	
					10	XZ CP0266L10	0.360	
M12	Ø 18, Ø 30			Straight	2	XZ CP1141L2	0.090	
					5	XZ CP1141L5	0.190	
					10	XZ CP1141L10	0.370	
				Elbowed	2	XZ CP1241L2	0.090	
		5	XZ CP1241L5		0.190			
		10	XZ CP1241L10		0.370			

Fixing accessories

Description	For use with sensor	Reference	Weight kg	
Fixing clamps	Ø 12	XSZ B112	0.006	
	Ø 18	XSZ B118	0.010	
90° fixing bracket	Ø 12	XXZ 12	0.025	
	Ø 18	XUZ A118	0.038	
	Ø 30	XXZ 30	0.115	
3D fixing kit (2)	M12 rod	Ø 12, Ø 18 and Ø 30	XUZ 2001	0.050
	Support for M12 rod	Ø 12, Ø 18 and Ø 30	XUZ 2003	0.160
	Ball-joint mounted fixing bracket	Ø 12	XUZ B2012	0.175
		Ø 18	XUZ B2003	0.175
		Ø 30	XUZ B2030	0.160

(1) Sensor available with stainless steel 303 case. To order, replace the 1st letter A by the letter S.
 (2) To obtain a 3D fixing kit, order:
 rod support XUZ 2003, M12 rod XUZ 2001 and ball-joint mounted fixing bracket XUZ B2003.
 (3) For 3-wire cabling accessories, refer to the Global Detection catalogue.

Ultrasonic sensors

Osisonic[®], Optimum and Universal
Cylindrical plastic case, M12 x 1, M18 x 1, M30 x 1.5
d.c. supply, solid-state output

Sensor type		XX5 12A1●●●●	XX5 12A2●●●●	XX5 18A1●●●●	XX5 18A3●●●●	XX6 30A1●●●●	XX6 30A3●●●●
Characteristics							
Product certifications		CE					
Conformity to standards		IEC 60947-5-2, UL508 pending and CSA C22-2 n° 14 pending					
Connection	Connector	M8 - 4-pin	M8 - 3-pin	M12 - 4-pin			
Sensing range	mm	6.4...51	6.4...102	19...152	51...508	51...991	203...8000
Nominal sensing distance (Sn)	m	0.05	0.1	0.15	0.50	1	8
Operating distance	mm	6.4...51 Fixed	6.4...102 Fixed	25...152 Fixed	Adjustable using teach mode		
Differential travel	mm	< 0.7	< 0.7	< 0.35	< 2.5	< 2.5	< 12.7
Blind zone (no object must pass through this zone whilst the sensor is operating)	mm	0...6.4	0...6.4	0...19	0...51	0...51	0...203
Transmission frequency	kHz	500			300	200	75
Repeat accuracy	mm	± 0.7			± 1.27	± 0.9	± 2.54
Overall beam angle (see detection lobe)		11°	10°	8°	6°	10°	16°
Minimum size of object to be detected		Cylinder Ø 2.5 mm or flat bar 1 mm wide		Cylinder Ø 1.6 mm	Cylinder Ø 2.5 mm up to a sensing distance of 150 mm	Cylinder Ø 1.6 mm up to a sensing distance of 635 mm	Cylinder Ø 50.8 mm up to a sensing distance of 4732 mm
Degree of protection	Conforming to IEC 60529 and IEC 60947-5-2	IP 67				IP 65	
Storage temperature	°C	- 40...+ 80					
Operating temperature	°C	- 20...+ 65		0...+ 50	- 20...+ 65	0...+ 60	- 20...+ 60
Materials	Case	ULTEM [®]			Valox [®]	ULTEM [®]	
	Sensing face	Epoxy		Silicone	Epoxy	Silicone	Epoxy
Vibration resistance	To IEC 60068-2-6	Amplitude ± 1 mm (f = 10...55 Hz)					
Mechanical shock resistance	To IEC 60068-2-27	30 gn, duration 11 ms, in all 3 axes					
Resistance to electromagnetic interference							
Electrostatic discharges	To IEC 61000-4-2	kV 8, level 4					
Radiated electromagnetic fields	To IEC 61000-4-3	V/m 10, level 3					
Fast transients	To IEC 61000-4-4	kV 1, level 3					
LED indicators	Output state	Yellow LED, rear	Yellow LED	–	Yellow LED	Yellow LED, rear	Yellow LED, rear
	Power on	Green LED, rear	Green LED	–	Green LED	–	–
	Setting-up assistance	–	–	–	Dual colour	Multicolour LED, rear	
Rated supply voltage	V	= 12...24 V with protection against reverse polarity					
Voltage limits (including ripple)	V	= 10...28 V					
Current consumption, no-load	mA	25		60	40	50	
Switching capacity	mA	< 100 (PNP and NPN) with overload and short-circuit protection					
Voltage drop	V	< 1 (PNP and NPN)					
Maximum switching frequency	Hz	125	125	80	40	10	2
Delays	First-up	ms 20	20	350	100	720	800
	Response	ms 2	3	3	10	20	200
	Recovery	ms 2	3	3	10	20	200
Deviation angle from 90° of the object to be detected		± 10°	± 10°	± 10°	± 7°	± 7°	± 5°

Setting-up precautions

Minimum mounting distances

Side by side

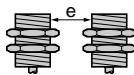

e: respect the distances indicated on the detection curves shown on page 13.

Face to face

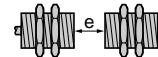

e = 4 x Sn max.

Ultrasonic sensors

Osisonic[®], Optimum and Universal
Cylindrical plastic case, M12 x 1, M18 x 1, M30 x 1.5
d.c. supply, solid-state output

Dimensions

XX5 12A●●AM8

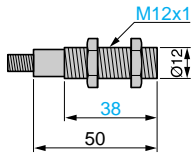

XX5 18A1KAM12

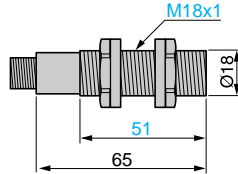

XX5 18A3●AM12

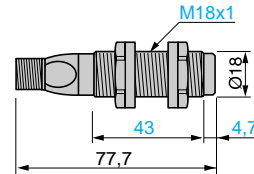

XXZ PB100

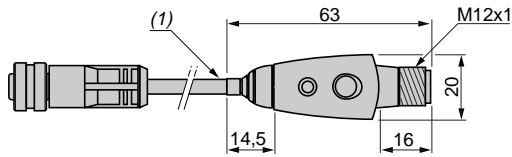

XX6 30A1KAM12

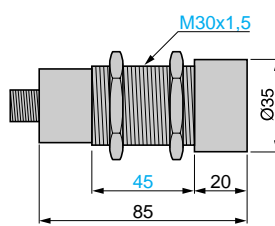

XX6 30A3●CM12

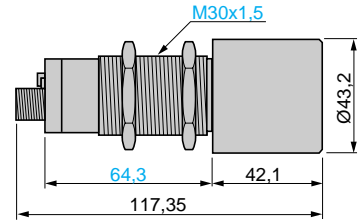

(1) Cable, length: 152.4 mm.

Accessories

XUZ A118

90° fixing bracket (Ø 18)

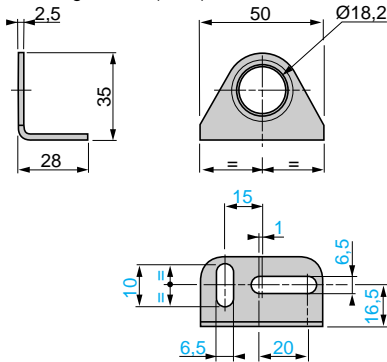

XXZ 12, XXZ 30

90° fixing bracket (Ø 12 and Ø 30)

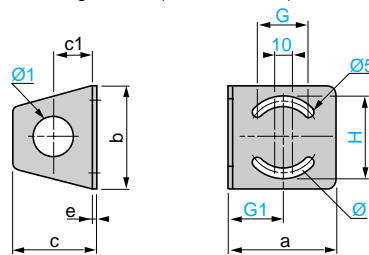

XXZ	a	b	c	c1	e	H	G	G1	Ø	Ø1
12	35	40	33	18	2	31	18	18	25	13
30	67	65	52	25	3	51	35	33	50	31

XSZ B112, XSZ B118

Fixing clamps (Ø 12 and Ø 18)

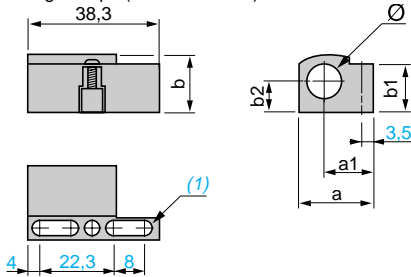

XSZ	a	a1	b	b1	b2	Ø
B112	21.9	14.5	16	15.5	8.5	12
B118	26	15.7	22.3	20.1	11.5	18

(1) 2 elongated holes Ø 4 x 8.

XUZ B2012

Ball-joint mounted fixing bracket (Ø 12)

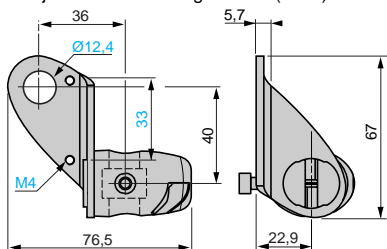

XUZ 2001

M12 rod

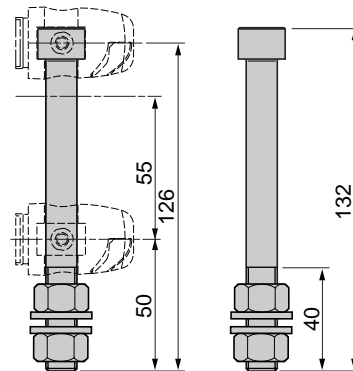

XUZ 2003

Support for M12 rod

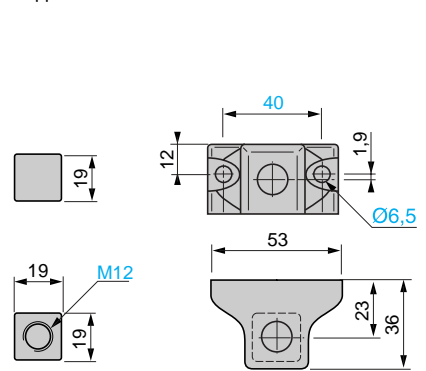

XUZ B2003

Ball-joint mounted fixing bracket (Ø 18)

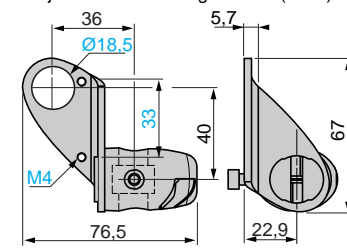

XUZ 2030

Ball-joint mounted fixing bracket (Ø 30)

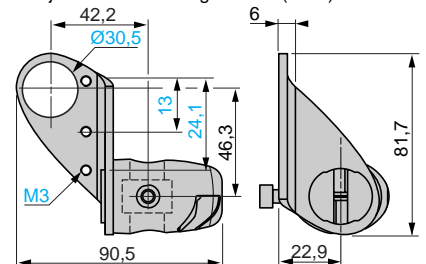

Ultrasonic sensors

Osisonic[®], Optimum and Universal
Cylindrical plastic case, M12 x 1, M18 x 1, M30 x 1.5
d.c. supply, solid-state output

Detection curves

XX5 12A1KAM8

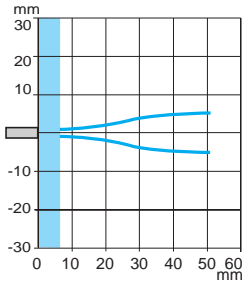

XX5 12A2●NAM8

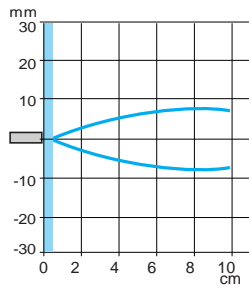

XX5 18A1KAM12

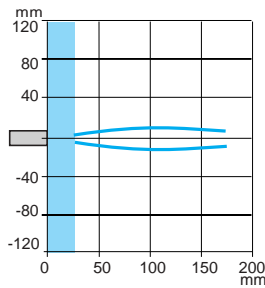

XX5 18A3●AM12

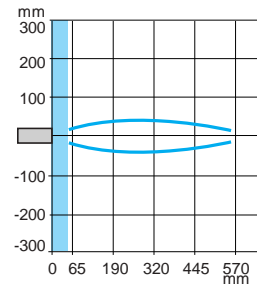

XX6 30A1●CM12

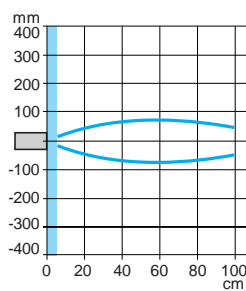

XX6 30A3●CM12

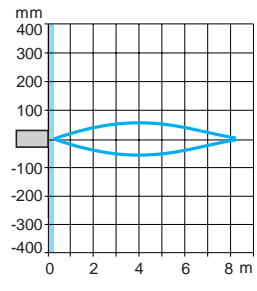

Blind zone

Wiring schemes

M8 connector

XX5 12A1KAM8

4-wire type

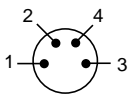

NO outputs, PNP and NPN

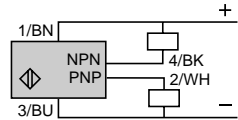

1 (+) 2 PNP output
3 (-) 4 NPN output

(-) BU (Blue) (+) BN (Brown)
WH (White) BK (Black)

XX5 12A2●

3-wire type

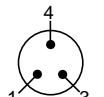

1 (+) 3 (-)
4 NPN or PNP output

NO outputs, NPN

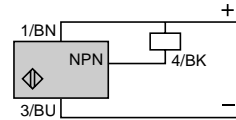

(-) BU (Blue) (+) BN (Brown)
BK (Black)

NO outputs, PNP

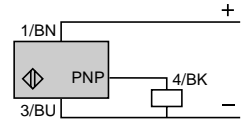

M12 connector

XX5 18A1KAM12

4-wire type

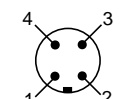

NO outputs, PNP and NPN

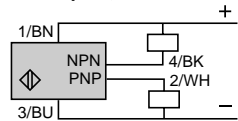

1 (+) 2 PNP output
3 (-) 4 NPN output

(-) BU (Blue) (+) BN (Brown)
WH (White) BK (Black)

XX5 18A3●

3-wire type

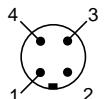

1 (+) 3 (-)
4 NPN or PNP output

NO outputs, NPN

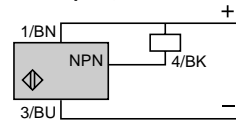

(-) BU (Blue) (+) BN (Brown)
BK (Black)

NO outputs, PNP

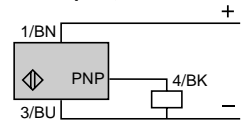

XX6 30A1KAM12

4-wire type

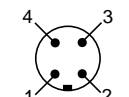

NO outputs, PNP and NPN

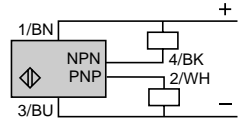

1 (+) 2 PNP output
3 (-) 4 NPN output

(-) BU (Blue) (+) BN (Brown)
WH (White) BK (Black)

XX6 30A3●CM12

NO + NC outputs, NPN

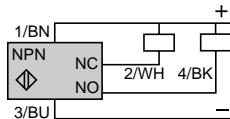

(-) BU (Blue) (+) BN (Brown)
WH (White) BK (Black)

NO + NC outputs, PNP

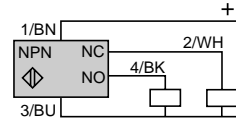

XXZ PB100 (teach mode pushbutton for XX5 18A3●AM12)

M12 female connector

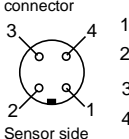

Sensor side

M12 male connector

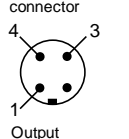

Output
XXZ PB100

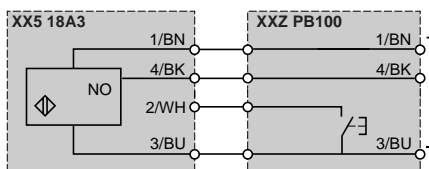

1 (+) BN (Brown) 2 WH (White)
3 (-) BU (Blue) 4 BK (Black)

Ultrasonic sensors

Osisonic[®], Application

Cylindrical plastic case, M30 x 1.5

Sensors with analogue output signal 0...10 V

or 4-20 mA

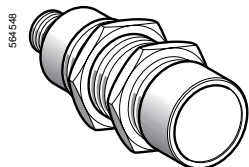

XX9 30A1A-M12

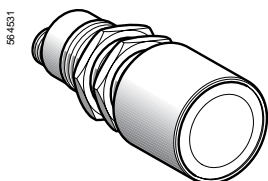

XX9 30A3A-M12

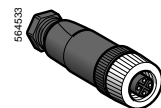

XZ CC12FD-40B

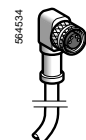

XZ CP1041L

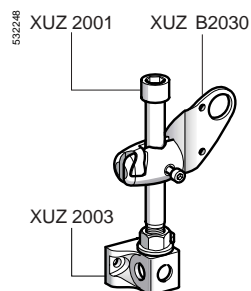

3D fixing kit example

Sensors

Sensors	Sensing distance (Sn) m	Function	Output	Reference	Weight kg
Ø 30	1 (adjustable)	–	Analogue 4-20 mA	XX9 30A1A2M12 (1)	0.095
	8 (adjustable)	–	Analogue 4-20 mA	XX9 30A3A2M12	0.115
	1 (adjustable)	–	Analogue 0-10 V	XX9 30A1A1M12 (1)	0.095
	8 (adjustable)	–	Analogue 0-10 V	XX9 30A3A1M12	0.115

Accessories

Cabling accessories

Connectors	Type		Reference	Weight kg
M12	Metal clamping ring	Straight	XZ CC12FDM40B	0.020
		Elbowed	XZ CC12FCM40B	0.020
	Plastic clamping ring	Straight	XZ CC12FDP40B	0.020
		Elbowed	XZ CC12FCP40B	0.020

Pre-wired connectors

M12	Type	Length m	Reference	Weight kg
	Straight	2	XZ CP1141L2	0.090
		5	XZ CP1141L5	0.190
		10	XZ CP1141L10	0.370
	Elbowed	2	XZ CP1241L2	0.090
		5	XZ CP1241L5	0.190
		10	XZ CP1241L10	0.370

Fixing accessories

Description	Reference	Weight kg
90° fixing bracket	XXZ 30	0.115
3D fixing kit (2) M12 rod	XUZ 2001	0.050
Support for M12 rod	XUZ 2003	0.160
Ball-joint mounted fixing bracket	XUZ B2030	0.160

(1) Sensor available with stainless steel 303 case. To order, replace the 1st letter A by the letter S.

(2) To obtain a 3D fixing kit, order:

rod support XUZ 2003, M12 rod XUZ 2001 and ball-joint mounted fixing bracket XUZ B2030

Ultrasonic sensors

Osisonic[®], Application

Cylindrical plastic case, M30 x 1.5

Sensors with analogue output signal 0...10 V
or 4-20 mA

Sensor type		XX9 30A1●●●●	XX9 30A3●●●●	
Characteristics				
Product certifications		CE		
Conformity to standards		IEC 60947-5-2, UL508 pending and CSA C22-2 n° 14 pending		
Connection	Connector	M12 - 4-pin		
Sensing range	mm	51...991	203...8000	
Nominal sensing distance (Sn)	m	1	8	
Operating distance	mm	Adjustable using teach mode	Adjustable using teach mode	
Blind zone (no object must pass through this zone whilst the sensor is operating)	mm	0...51	0...203	
Transmission frequency	kHz	200	75	
Repeat accuracy	mm	± 0.9	± 2.54	
Overall beam angle (see detection lobe)		10°	16°	
Minimum size of object to be detected		Cylinder Ø 1.6 mm up to a sensing distance of 635 mm	Cylinder Ø 50.68 mm up to a sensing distance of 4732 mm	
Degree of protection	Conforming to IEC 60529 and IEC 60947-5-2	IP 65		
Storage temperature	°C	- 40...+ 80	- 40...+ 80	
Operating temperature	°C	0...+ 50	- 20...+ 60	
Materials	Case	ULTEM [®]		
	Sensing face	Silicone membrane	Epoxy	
Vibration resistance	To IEC 60068-2-6	Amplitude ± 1 mm (f = 10...55 Hz)		
Mechanical shock resistance	To IEC 60068-2-27	30 gn, duration 11 ms, in all 3 axes		
Resistance to electromagnetic interference				
Electrostatic discharges	To IEC 61000-4-2	kV	8, level 4	
Radiated electromagnetic fields	To IEC 61000-4-3	Vm	10, level 3	
Fast transients	To IEC 61000-4-4	kV	1, level 3	
LED indicators	Output state	Yellow LED, rear	Yellow LED, rear	
	Power on	–	–	
	Setting-up assistance	Multicolour LED, rear	Multicolour LED, rear	
Rated supply voltage	V	= 15...24 V with protection against reverse polarity		
Voltage limits (including ripple)	V	= 10...28 V		
Current consumption, no-load	mA	60		
Switching capacity		Analogue output 4-20 mA: resistive load from 10 to 500 Ω max. Analogue output 0-10 V: resistive load from 1kΩ to unlimited Overload and short-circuit protection		
Delays	First-up	ms	720	1200
	Response	ms	25	250
	Recovery	ms	25	250
Deviation angle from 90° of the object to be detected			± 8°	± 5°

Setting-up precautions

Minimum mounting distances

Side by side

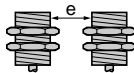

e: respect to the distances indicated on the detection curves shown on page 17.

Face to face

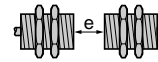

e = 4 x Sn max.

Ultrasonic sensors

Osisonic[®], Application

Cylindrical plastic case, M30 x 1.5

Sensors with analogue output signal 0...10 V or 4-20 mA

Dimensions

XX9 30A1A●M12

XX9 30A3A●M12

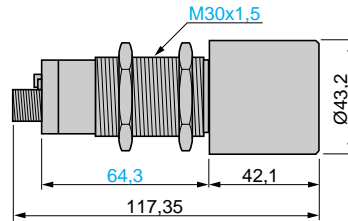
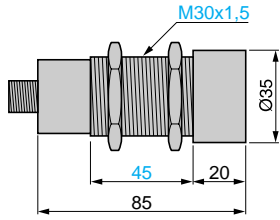

Accessories

XXZ 30

90° fixing bracket

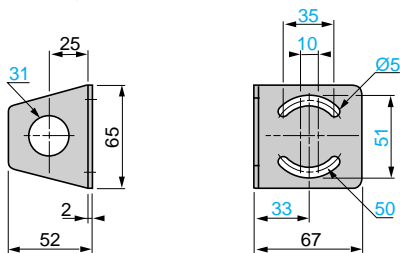

XUZ 2001

M12 rod

XUZ 2003

Support for M12 rod

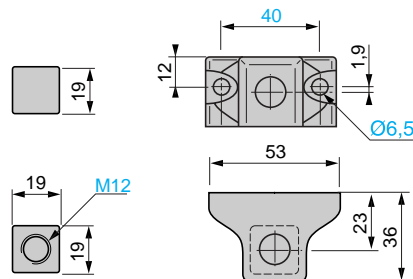
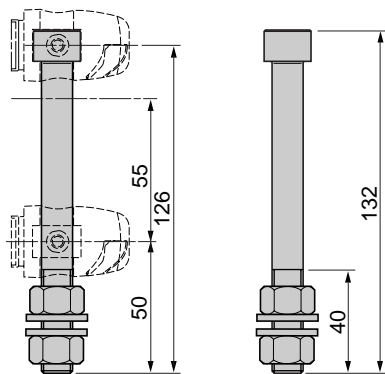

XUZ B2030

Ball-joint mounted fixing bracket

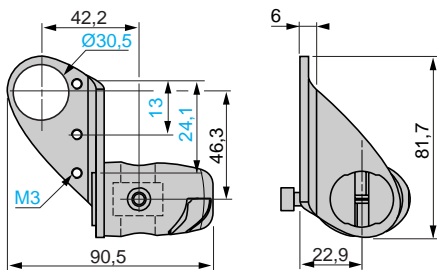

Ultrasonic sensors

Osisonic[®], Application

Cylindrical plastic case, M30 x 1.5

Sensors with analogue output signal 0...10 V
or 4-20 mA

Curves

Detection curves

XX9 30A1A●M12

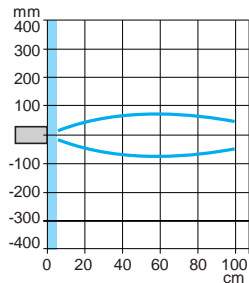

XX9 30A3A●M12

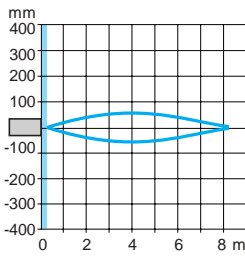

Blind zone

Output signal curves

Sensors	Sensing range D (mm)	Output	Maximum sensing range (in % of maximum value)
XX930A1A1●	51...991	0-10 V	< 0.5%
XX930A1A2●	51...991	4-20 mA	< 0.5%
XX930A3A1●	223...8000	0-10 V	< 0.5%
XX930A3A2●	223...8000	4-20 mA	< 0.5%

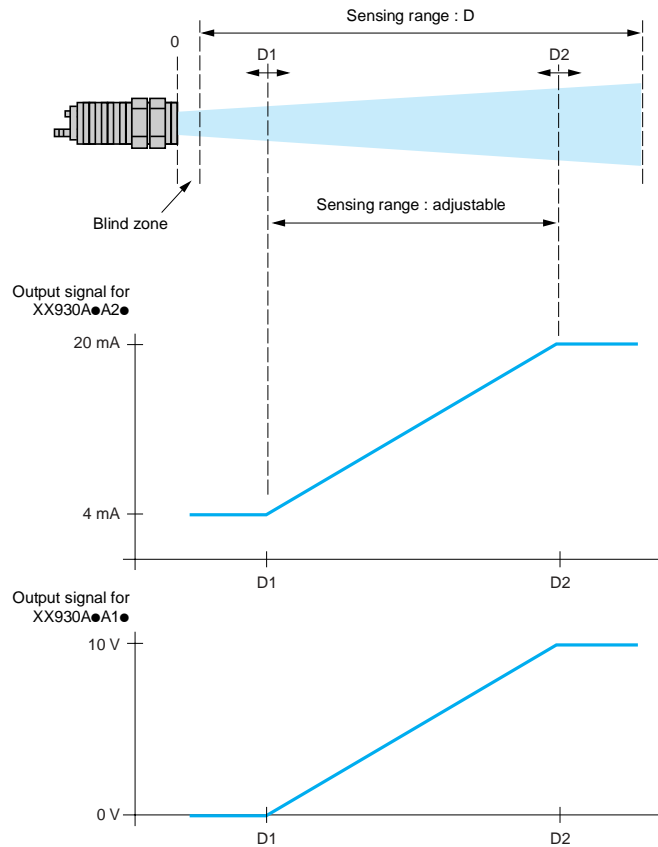

Wiring schemes

M12 connector

XX9 30A●A1M12

XX9 30A●A2M12

4-wire type

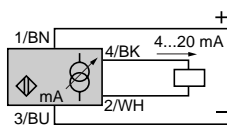
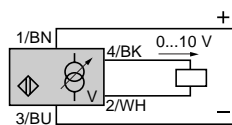
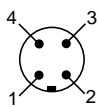

- 1 (+)
- 2 Signal return
- 3 (-)
- 4 Output signal

- (-) BU (Blue)
- (+) BN (Brown)
- WH (White)
- BK (Black)

Ultrasonic sensors

Osisonic[®], Optimum and Universal

Plastic case, flat form

d.c. supply, solid-state output

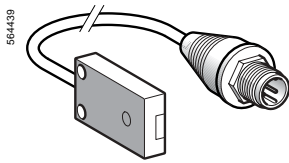

XX7 F1A2-AL01M12

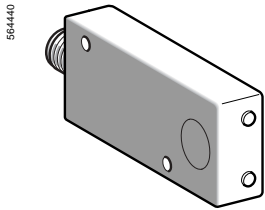

XX7 K1A2-AM12

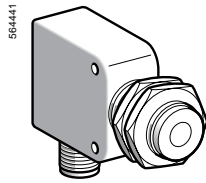

XX7 V1A1-AM12

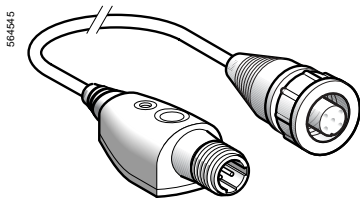

XXZ PB100

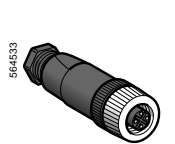

XZ CC12FD-40B

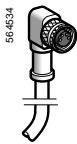

XZ CP1141L

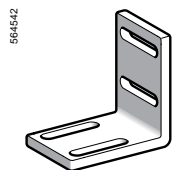

XXZ 1933

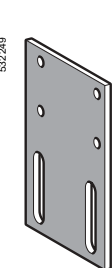

XXZ 3074F

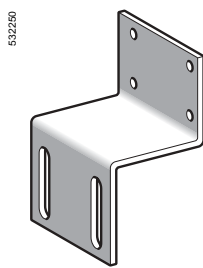

XXZ 3074S

Optimum sensors

Sensors	Sensing distance (S _n)	Function	Output	Reference	Weight
mm	m				kg
7.6 x 19 x 33	0.10	NO	NPN	XX7 F1A2NAL01M12	0.040
			PNP	XX7 F1A2PAL01M12	0.040
16 x 30 x 74	0.25	NO	NPN	XX7 K1A2NAM12	0.050
			PNP	XX7 K1A2PAM12	0.050

Universal sensors

18 x 33 x 60 + Ø 18	0.50 (adjustable)	NO	NPN	XX7 V1A1NAM12	0.060
			PNP	XX7 V1A1PAM12	0.060

Accessories

Description	For use with sensor	Reference	Weight
Teach mode pushbutton	XX5 18A3-AM12	XXZ PB100	0.035
Selection of detection window	and XX7 V1A1-AM12		
Input:			
M12 female connector			
Output:			
M12 male connector			

Cabling accessories

Connectors	For use with sensor	Type	Reference	Weight	
M12	XX7 ●●●●	Metal clamping ring	Straight	XZ CC12FDM40B	0.020
			Elbowed	XZ CC12FCM40B	0.020
		Plastic clamping ring	Straight	XZ CC12FDP40B	0.020
			Elbowed	XZ CC12FCP40B	0.020

Pre-wired connectors	For use with sensor	Type	Length m	Reference	Weight
M12	XX7 ●●●●	Straight	2	XZ CP1141L2	0.090
			5	XZ CP1141L5	0.190
			10	XZ CP1141L10	0.370
		Elbowed	2	XZ CP1241L2	0.090
			5	XZ CP1241L5	0.190
			10	XZ CP1241L10	0.370

Fixing accessories

Description	For use with sensor	Reference	Weight
90° fixing bracket	XX7 F	XXZ 1933	0.025
Flat mounting plate	XX7 K	XXZ 3074F	0.025
Cranked mounting plate	XX7 K	XXZ 3074S	0.075

Sensor type		XX7 F1A2●AL01M12	XX7 K1A2●AM12	XX7 V1A1●AM12
Characteristics				
Product certifications		CE		
Conformity to standards		IEC 60947-5-2, UL508 pending and CSA C22-2 n° 14 pending		
Connection	Connector	M12 - 4-pin, on 152 mm flying lead	M12 - 4-pin	M12 - 4-pin
Sensing range	mm	6.2...102	51...254	51...508
Nominal sensing distance (Sn)	m	0.1	0.25	0.5
Operating distance	mm	6.4...102 Fixed	51...254 Fixed	Adjustable using teach mode
Differential travel	mm	< 0.7	< 0.35	< 2.5
Blind zone (no object must pass through this zone whilst the sensor is operating)	mm	0...6.4	0...51	0...51
Transmission frequency	kHz	500	500	300
Repeat accuracy	mm	± 0.7	± 0.7	± 1.27
Overall beam angle (see detection lobe)		14°	14°	12°
Minimum size of object to be detected		Cylinder Ø 2.5 mm or flat bar 1 mm wide	Cylinder Ø 1.6 mm	Cylinder Ø 2.5 mm or flat bar 1 mm wide for a sensing distance of 150 mm
Degree of protection	Conforming to IEC 60529 and IEC 60947-5-2	IP 67		
Storage temperature	°C	- 40...+ 80		
Operating temperature	°C	- 20...+ 65	0...+ 50	- 20...+ 65
Materials	Case	ULTEM [®]	ULTEM [®]	Valox [®]
	Sensing face	Epoxy	Silicone	Epoxy
Vibration resistance	To IEC 60068-2-6	Amplitude ± 1 mm (f = 10...55 Hz)		
Mechanical shock resistance	To IEC 60068-2-27	30 gn, duration 11 ms, in all 3 axes		
Resistance to electromagnetic interference				
Electrostatic discharges	To IEC 61000-4-2	kV 8, level 4		
Radiated electromagnetic fields	To IEC 61000-4-3	V/m 10, level 3		
Fast transients	To IEC 61000-4-4	kV 1, level 3		
LED indicators	Output state	Dual colour LED, yellow	Yellow LED	Dual colour LED, yellow
	Power on	Dual colour LED, green	Green LED	Dual colour LED, green
	Setting-up assistance	-	-	-
Rated supply voltage	V	= 12...24 V with protection against reverse polarity		
Voltage limits (including ripple)	V	= 10...28 V		
Current consumption, no-load	mA	25	60	40
Switching capacity	mA	< 100 (PNP and NPN)		
Voltage drop	V	< 1 (PNP and NPN)		
Maximum switching frequency	Hz	100	80	40
Delays	First-up	ms 20	350	100
	Response	ms 4	5	10
	Recovery	ms 4	5	10

Setting-up precautions

Minimum mounting distances

Side by side

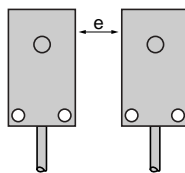

Face to face

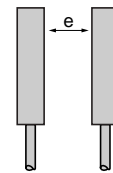

e: respect the distances indicated on the detection curves shown on page 21.

$e \geq 4 \times S_n \text{ max.}$

Ultrasonic sensors

Osisonic[®], Optimum and Universal

Plastic case, flat form

d.c. supply, solid-state output

Dimensions

XX7 F1A2●AL01M12

XX7 K1A2●AM12

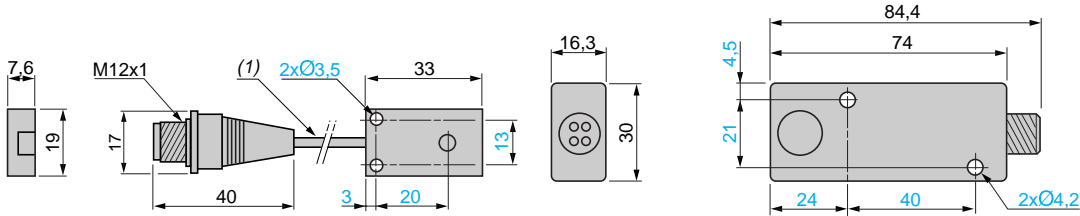

(1) Cable, length: 152 mm.

XX7 V1A1●AM12

XXZ PB100

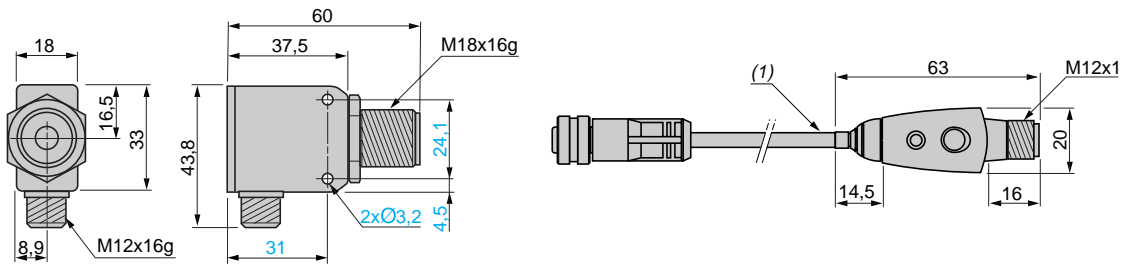

(1) Cable, length: 152.4 mm.

Fixing accessories

XXZ 1933

90° fixing bracket

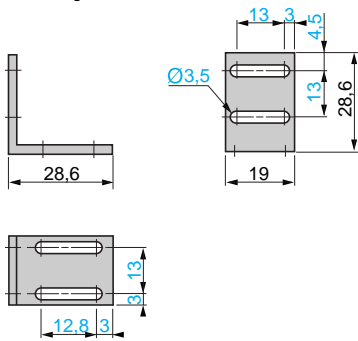

XXZ 3074F

Flat mounting plate

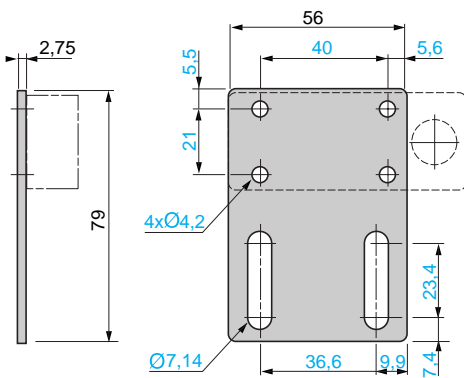

XXZ 3074S

Cranked mounting plate

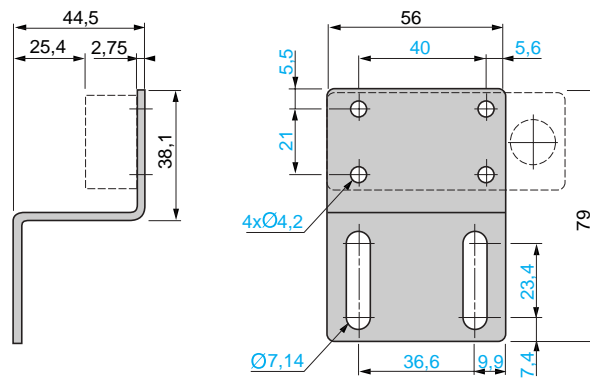

Detection curves

XX7 F1A2●AL01M12

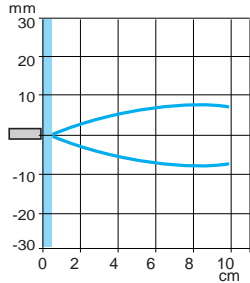

XX7 K1A2●AM12

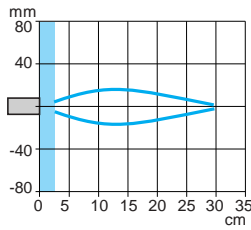

XX7 V1A1●AM12

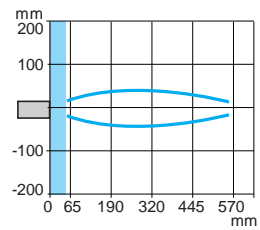

Blind zone

Wiring schemes

M12 connector

3-wire type

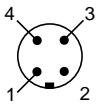

- 1 (+)
- 2 On sensors XX7 V1A1●AM12, terminal 2 is reserved for the teach mode pushbutton.
- 3 (-)
- 4 NPN or PNP output

XX7 F1A2NAL01M12 (1),
XX7 K1A2NAM12, XX7 V1A1NAM12

NO outputs, NPN

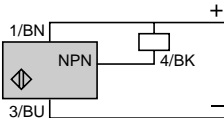

- (-) BU (Blue)
- (+) BN (Brown)
- BK (Black)

XX7 F1A2PAL01M12 (1),
XX7 K1A2PAM12, XX7 V1A1PAM12

NO outputs, PNP

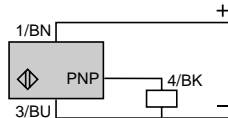

(1) Remote connector on flying lead approximately 15 cm long.

XXZ PB100 (teach mode pushbutton for XX7 V1A1●AM12)

M12 female connector

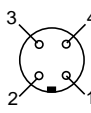

Sensor side

M12 male connector

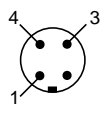

Output
XXZ PB100

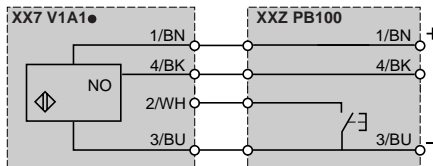

- 1 (+) BN (Brown)
- 2 WH (White)
- 3 (-) BU (Blue)
- 4 BK (Black)

The efficiency of Telemecanique branded *solutions*

Used in combination, Telemecanique products provide quality solutions, meeting all your **Automation & Control** applications requirements.



A worldwide presence

Constantly available

- More than 5 000 points of sale in 130 countries.
- You can be sure to find the range of products that are right for you and which complies fully with the standards in the country where they are used.

Technical assistance wherever you are

- Our technicians are at your disposal to assist you in finding the optimum solution for your particular needs.
- Schneider Electric provides you with all necessary technical assistance, throughout the world.



Schneider Electric Industries S.A.S.

Head Office
89, bd Franklin Roosevelt
92504 Rueil-Malmaison Cedex
FRANCE

www.schneider-electric.com
www.telemecanique.com

Due to evolution of standards and equipment, the characteristics indicated in texts and images of this document do not constitute a commitment on our part without confirmation.

Design: Schneider Electric
Photos: Schneider Electric
Printed by:

Simply Smart !